

PERFIL/PROFILE:

A20 R10

NOMBRE/NAME:

HALF BULLNOSE-20

A20
 EXC SIL R10

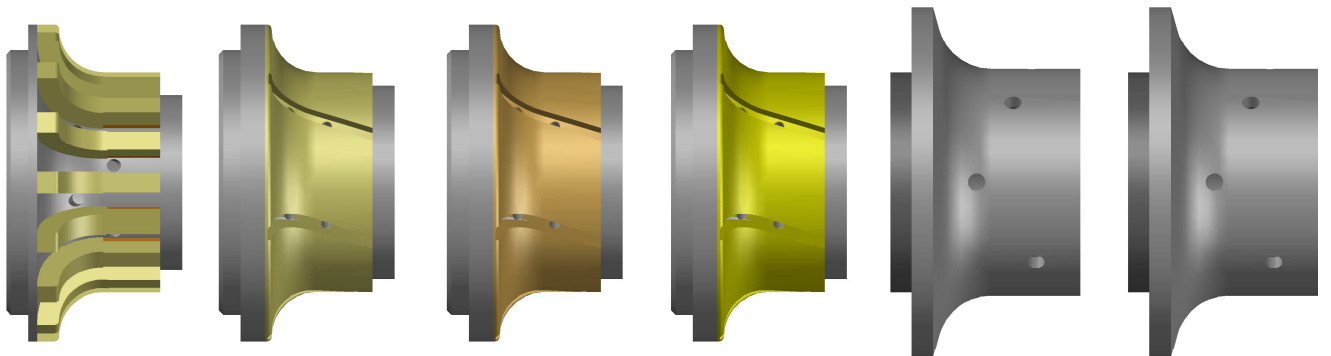
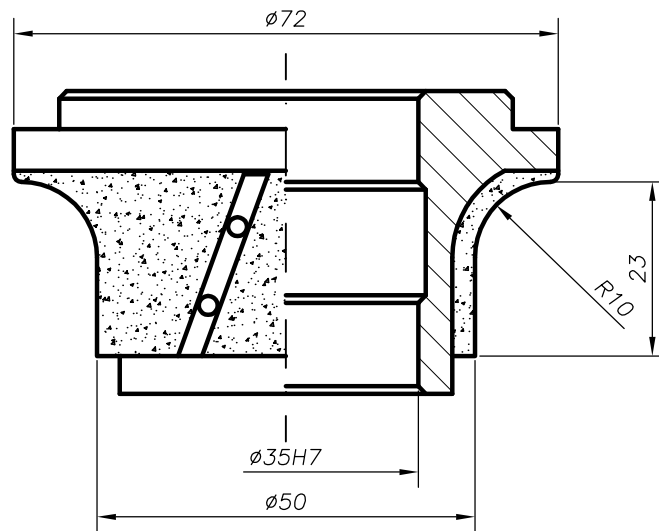

	POS.	CODIGO/CODE	DESCRIPCION/DESCRIPTION
METALICA METALLIC	1	-	CNC 35 D72 ALEX (A20 R10) M P.1 SEG VIT
	2	-	CNC 35 D72 ALEX (A20 R10) M P.2 VIT
	3	-	CNC 35 D72 ALEX (A20 R10) M P.3 VIT
	4	-	CNC 35 D72 ALEX (A20 R10) M P.4 VIT
DIAMLOX	5	-	CNC 35 D90 ALEX (A20 R10) DIAMLOX 800
	6	-	CNC 35 D90 ALEX (A20 R10) DIAMLOX 1200